

**MCR-600 CD CLOCK RADIO**



**Need help? Call us!**

Magnavox representatives are ready to help you with any questions about your new product. We can guide you through Connections, First-time Setup, or any of the Features. We want you to start enjoying your new product right away!

**CALL US BEFORE YOU CONSIDER RETURNING THE PRODUCT!**

**1-800-705-2000**

or

Visit us on the web at [www.magnavox.com](http://www.magnavox.com)



**Return your Warranty Registration card today to ensure you receive all the benefits you're entitled to.**

- Once your Magnavox purchase is registered, you're eligible to receive all the privileges of owning a Magnavox product.
- So complete and return the Warranty Registration Card enclosed with your purchase at once, and take advantage of these important benefits.

**Warranty Verification**

Registering your product within 10 days confirms your right to maximum protection under the terms and conditions of your Magnavox warranty.

**Owner Confirmation**

Your completed Warranty Registration Card serves as verification of ownership in the event of product theft or loss.

**Model Registration**

Returning your Warranty Registration Card right away guarantees you'll receive all the information and special offers which you qualify for as the owner of your model.

Know these *safety* symbols



This "bolt of lightning" indicates uninsulated material within your unit which may cause an electrical shock. For the safety of everyone in your household, please do not remove product covering.

The "exclamation point" calls attention to features for which you should read the enclosed literature closely to prevent operating and maintenance problems.

**For Customer Use**  
Enter below the Serial No. which is located on the bottom of the cabinet. Retain this information for future reference.

Model No. \_\_\_\_\_

Serial No. \_\_\_\_\_

**WARNING:** TO REDUCE THE RISK OF FIRE OR ELECTRIC SHOCK, THIS SHOULD NOT EXPOSED TO RAIN OR MOISTURE, AND OBJECTS FILLED WITH LIQUIDS, SUCH AS VASES, SHOULD NOT BE PLACED ON THIS APPARATUS.

**CAUTION:** To prevent electric shock, match wide blade of plug to wide slot, and fully insert.

MAC5097

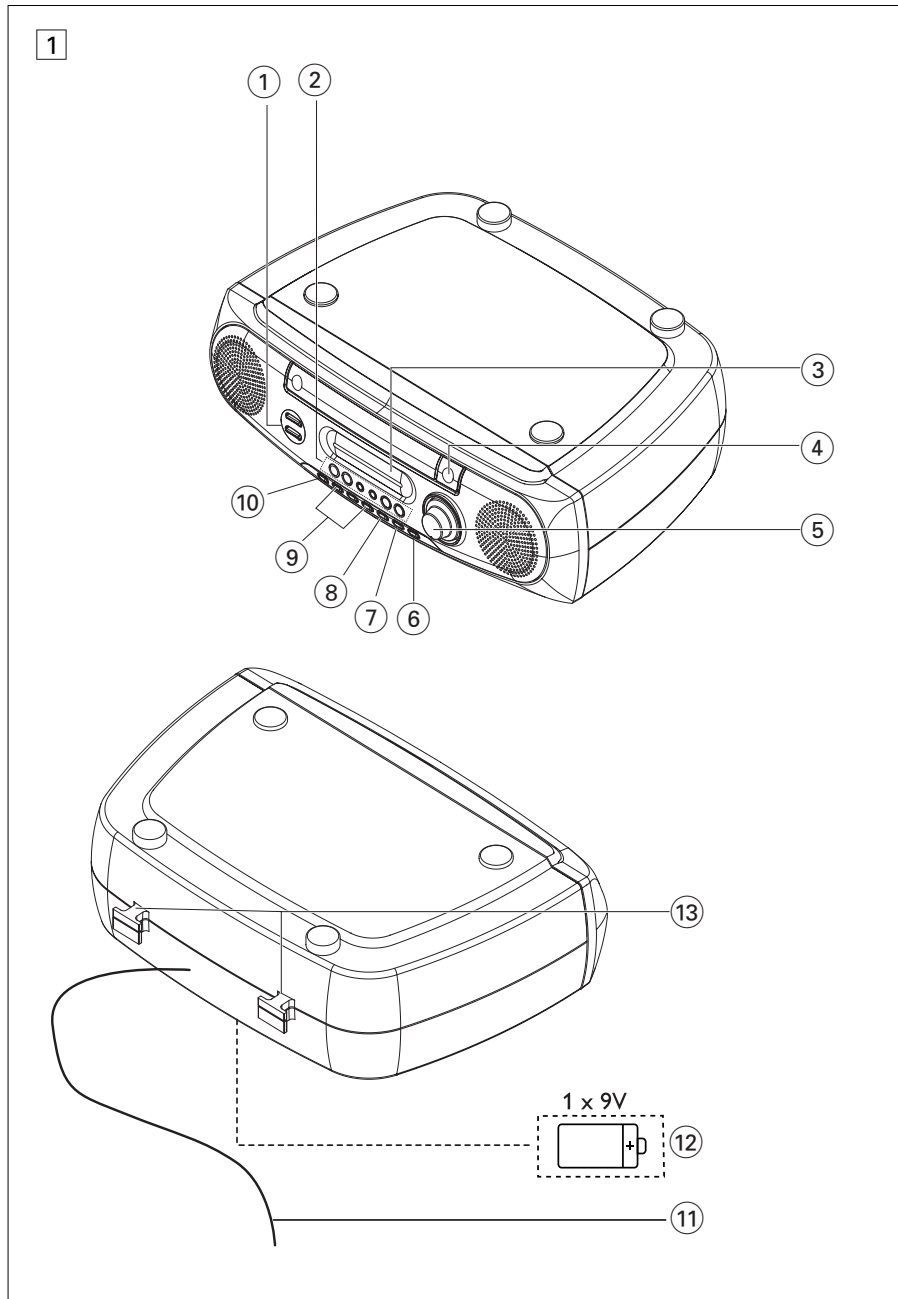

**PHILIPS CONSUMER ELECTRONICS NORTH AMERICA**

Knoxville, Tennessee 37914-1810, U.S.A.

Meet Magnavox at the Internet  
<http://www.magnavox.com>

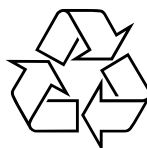

MCR600

**CLASS 1  
LASER PRODUCT**

**IMPORTANT SAFETY INSTRUCTIONS**

1. Read these instructions.
2. Keep these instructions.
3. Heed all warnings.
4. Follow all instructions.
5. Do not use this apparatus near water.
6. Clean only with dry cloth.
7. Do not block any ventilation openings. Install in accordance with the manufacturer's instructions.
8. Do not install near any heat sources such as radiators, heat registers, stoves, or other apparatus (including amplifiers) that produce heat.
9. Do not defeat the safety purpose of the polarized or grounding-type plug. A polarized plug has two blades with one wider than the other. A grounding type plug has two blades and a third grounding prong. The wide blade or the third prong are provided for your safety. If the provided plug does not fit into your outlet, consult an electrician for replacement of the obsolete outlet.
10. Protect the power cord from being walked on or pinched, particularly at plugs, convenience receptacles, and the point where they exit from the apparatus.
11. Only use attachments/accessories specified by the manufacturer.
12. Use only with the cart, stand, tripod, bracket, or table specified by the manufacturer or sold with the apparatus. When a cart is used, use caution when moving the cart/apparatus combination to avoid injury from tip-over.
13. Unplug this apparatus during lightning storms or when unused for long periods of time.
14. Refer all servicing to qualified service personnel. Servicing is required when the apparatus has been damaged in any way, such as power-supply cord or plug is damaged, liquid has been spilled or objects have fallen into the apparatus, the apparatus has been exposed to rain or moisture, does not operate normally, or has been dropped.
15. Battery usage **CAUTION** - To prevent battery leakage which may result in bodily injury, property damage, or damage to the unit:
  - Install all batteries correctly, + and - as marked on the unit.
  - Do not mix batteries (old and new or carbon and alkaline, etc.).
  - Remove batteries when the unit is not used for a long time.
16. Apparatus shall not be exposed to dripping or splashing.
17. Do not place any sources of danger on the apparatus (e.g. liquid filled objects, lighted candles).
18. This product may contain lead and mercury. Disposal of these materials may be regulated due to environmental considerations. For disposal or recycling information, please contact your local authorities or the Electronic Industries Alliance : [www.eiae.org](http://www.eiae.org).

EL 6475-E005: 04/01

**Class II equipment symbol**



This symbol indicates that the unit has a double insulation system.

**LIMITED WARRANTY**

**PORTABLE AUDIO**

90 Days Free Exchange

This product must be carried in for an exchange.

**WHO IS COVERED?**

You must have proof of purchase to exchange the product. A sales receipt or other document showing that you purchased the product is considered proof of purchase. Attach it to this owner's manual and keep both nearby.

**WHAT IS COVERED?**

Warranty coverage begins the day you buy your product. For 90 days thereafter, a defective or inoperative product will be replaced with a new, renewed or comparable product at no charge to you. A replacement product is covered only for the original warranty period. When the warranty on the original product expires, the warranty on the replacement product also expires.

**WHAT IS EXCLUDED?**

- Your warranty does not cover:
- labor charges for installation or setup of the product, adjustment of customer controls on the product, and installation or repair of antenna systems outside of the product.
  - product repair and/or part replacement because of misuse, accident, unauthorized repair or other cause not within the control of Magnavox.
  - reception problems caused by signal conditions or cable or antenna systems outside the unit.
  - a product that requires modification or adaptation to enable it to operate in any country other than the country for which it was designed, manufactured, approved and/or authorized, or repair of products damaged by these modifications.
  - incidental or consequential damages resulting from the product. (Some states do not allow the exclusion of incidental or consequential damages, so the above exclusion may not apply to you. This includes, but is not limited to, prerecorded material, whether copyrighted or not copyrighted.)
  - a product used for commercial or institutional purposes.

**WHERE IS EXCHANGE AVAILABLE?**

You may exchange the product in all countries where the product is officially distributed by Magnavox. In countries where Magnavox does not distribute the product, the local Magnavox service organization will attempt to provide a replacement product (although there may be a delay if the appropriate product is not readily available).

**BEFORE REQUESTING EXCHANGE...**

Please check your owner's manual for assistance. If you have additional questions, call us at 1-800-705-2000.

**EXCHANGING A PRODUCT IN U.S.A., PUERTO RICO, OR U.S. VIRGIN ISLANDS...**

Contact 1-800-705-2000 to arrange an exchange. Or, ship the product, insured and freight prepaid, and with proof of purchase enclosed, to the address listed below.

Magnavox Exchange Program  
Suite A  
406 North Irish Street  
Greenville TN 37745

(In U.S.A., Puerto Rico, and U.S. Virgin Islands, all implied warranties, including implied warranties of merchantability and fitness for a particular purpose, are limited in duration to the duration of this express warranty. But, because some states do not allow limitations on how long an implied warranty may last, this limitation may not apply to you.)

**EXCHANGING A PRODUCT IN CANADA...**

Please contact Magnavox at:

1-800-661-6162 (French Speaking)  
1-800-705-2000 (English or Spanish Speaking)

(In Canada, this warranty is given in lieu of all other warranties. No other warranties are expressed or implied, including any implied warranties of merchantability or fitness for a particular purpose. Magnavox is not liable under any circumstances for any direct, indirect, special, incidental or consequential damages, howsoever incurred, even if notified of the possibility of such damages.)

**REMEMBER...**

Please record below the model and serial numbers found on the product. Also, please fill out and mail your warranty registration card promptly. It will be easier for us to notify you if necessary.

MODEL # \_\_\_\_\_

SERIAL # \_\_\_\_\_



**CONTROLS (see Fig. 1)**

- ① **Source selectors** – selects **CD** or **TUNER** function.
- ② **BAND** – selects FM/AM wavebands;  
▶|| – starts or pauses CD playback;  
**SEARCH/TUNING** ◀◀, ▶▶ :  
**CD** : skips or searches a CD track/passage backward or forward;  
**TUNER** : tunes to radio stations;  
**CLOCK** : adjusts the hours/minutes for clock time;  
■ – stops CD playback  
– erases a CD program.  
**PROG/CLOCK** :  
**CD** : programs tracks and review the program;  
**TUNER** : programs preset radio stations;  
**CLOCK** : sets the clock time.
- ③ **Display** – shows the status of the set.
- ④ **OPEN•CLOSE** – press to open/close the CD compartment.
- ⑤ **VOLUME** – adjusts volume level.
- ⑥ **SLEEP** – activates/ deactivates sleep timer function to automatically switch off tuner/ CD playback;  
– adjusts sleep timer options.
- ⑦ **DISPLAY** – toggles to show clock time /elapsed CD play time or remaining CD playback time.
- ⑧ **REPEAT/PRESET**  
– repeats a CD track/program/the entire CD;  
– selects a preset radio station.
- ⑨ **TIMER** – alarm timer with 3 setting options: **10**, **3** and **1** minute.

- ⑩ **POWER** – switches the CD/ tuner function on/off.
- ⑪ **Power cord** – connect to AC power supply.
- ⑫ **battery compartment** – Open to insert 1 x 9V battery (for memory backup power supply only).
- ⑬ **Power cord posts** – for wrapping the power cord so that excess cord does not hang down

**Supplied Accessories  
Mounting kit:**

- 4 x spacers
- 4 x "Phillips" head screws
- 1 x mounting template

*For mounting instructions, please refer to 'How to Mount MCR600'.*

**CAUTION**

*To reduce the risk of fire, do not place any heating or cooking apparatus beneath this unit.*

*To prevent obstruction or danger, use the power cord posts to wrap the power cord so that excess cord does not hang down.*

**CD PLAYER****Programming tracks**

Program in the stop position to select and store your CD tracks in the desired sequence. If you like, store any track more than once. Up to 20 tracks (**P-01** - **P-20**) can be stored in the memory.

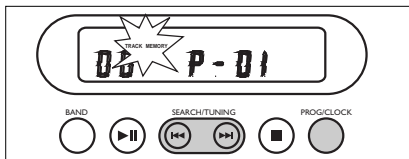

1. Press **PROG/CLOCK** to activate programming.  
→ Display: **TRACK MEMORY** flashes. □□ prompts you to select a track number. **P-01** indicates the start of the program.
2. Press ◀◀ or ▶▶ to select your desired track.
3. Press **PROG** to confirm.  
→ Display: **TRACK MEMORY** flashes. □□ prompts you to select a track number. **P-02** appears to indicate the next program location available.
4. Repeat 3-4 to select and store all desired tracks.

**Helpful Hints:**

– If you fail to execute any action within 7 seconds after pressing **PROG/CLOCK**, programming will stop and you will need to start again.

**To start playback of your program**

- Press ▶||.

**Reviewing the program**

In the stop position, press **PROG/CLOCK** once or repeatedly to display all the stored tracks in sequence.

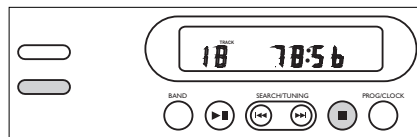
**Erasing the program**

You can erase the contents of the memory by:

- opening the CD door;
- selecting **TUNER**;
- pressing ■ twice during playback or once in the stop position.

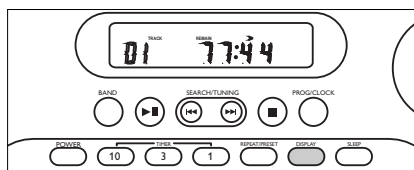
**DISPLAY**

- Press **DISPLAY** once or more \* to toggle to check the clock time during CD/ Tuner playback.

**Helpful Hints:**

\* For CDs, you can also select to view: **elapsed CD play time** or **'REMAIN' remaining CD playback time**.

– Viewing the remaining CD playback time is not available during CD playback in any **REPEAT** mode.

**AC power**

This set runs on AC power.

We recommend you also insert a **9V battery** for memory back-up power supply. In the event of a power interruption, this will help safeguard the clock, timer settings and preset radio stations. To save energy, the display switches off and you will not be able to operate the CD/ Tuner functions.

**AC power**

1. Check if the AC power supply, as shown on the type plate located on the bottom of the set, corresponds to your local power supply. If it does not, consult your dealer or service center.
2. Connect the power cord to the wall outlet. The set is now ready for use.

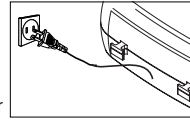
**Helpful Hints:**

– To disconnect the power supply, unplug the set from the wall outlet.

– Disconnect the power supply to protect your set during heavy thunderstorms.

**Backup battery (not included. See 1)**

- Insert 1 x 9V battery (preferably alkaline) with the correct polarity.

**Helpful Hints:**

– Change the battery twice a year or as often as required to ensure fresh battery supply and to prevent battery leakage. To safeguard the clock, timer and preset station settings, keep the set connected to AC power when replacing the battery.

– Incorrect use of batteries can cause electrolyte leakage and will corrode the compartment or cause the batteries to burst.

**Batteries contain chemical substances, so they should be disposed of properly.**

**SLEEP****About SLEEP**

This set has a built-in "sleep" timer which enables the set to be automatically switched off during CD/ tuner playback after a selected period of time. You can choose from 9 sleep time options (90, 80, 70...10 minutes).

**Setting SLEEP**

To select the 90 minute SLEEP option:

- During CD/ tuner playback, briefly press **SLEEP** once.  
→ Display shows **SLEEP** and 90.

To select other SLEEP time options:

1. During CD/ tuner playback, press and hold **SLEEP**.  
→ Display shows **SLEEP** and the options in sequence: 90 80 70 60 50 40 30 20 10 90....
2. Release **SLEEP** when your desired option appears.

**To cancel the SLEEP timer, you can either:**

- Press **SLEEP** briefly once again.
- Press **POWER**.  
→ Display: **SLEEP** disappears.

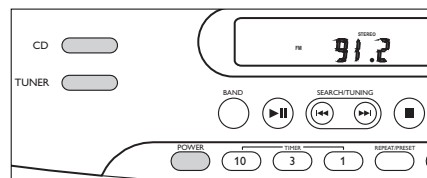
**Switching CD/ Tuner on/off**

1. To switch on, press **POWER**.  
→ The set automatically powers on the last sound source played.
2. Press **CD** or **TUNER** to select your desired function.
3. To switch off, press **POWER**.  
→ The set returns to clock standby mode.

**Adjusting volume**

- Adjust the CD/ Tuner volume with the **VOLUME** control.

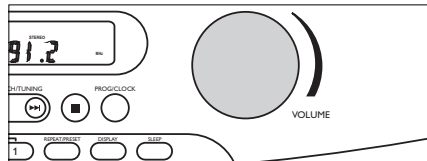
**Setting the clock**

The clock is displayed using the 12-hour clock with **PM** and **AM** indicators.

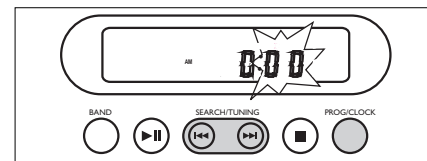

1. Check you have switched off the CD/Tuner.
2. Press **PROG/CLOCK** to activate clock setting.  
→ The respective hour/ minute setting flashes.
3. Use **SEARCH/TUNING** ◀◀, ▶▶ to adjust the hours/ minutes.
4. Press **PROG/CLOCK** to store the hour/ minute setting.

**About TIMER**

The **TIMER** is an **alarm beeper function**.

With the **TIMER** buttons **10**, **3** or **1**, you can set a time (minimum 1 minute, maximum 99 minutes) to activate a beeper during clock standby mode, or CD/ tuner playback.

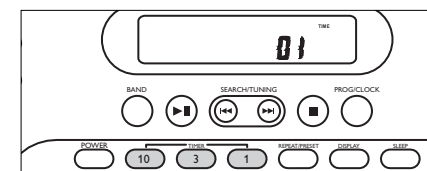
**To set a TIMER period:**

The **TIMER** period increases by steps of 10, 3 or 1, or their multiples. You can also press a combination of the **TIMER** digits to set the **TIMER** alarm.

- Press **10**, **3** or **1** once, or repeatedly to set/ adjust the time.  
→ Display: **TIME** appears.

E.g. to set **TIMER** for :

- 1 minute, press **1**.
- 17 minutes, press **10**, **3**, **1**.

**Helpful Hints:**

– The beeper is set at a fixed volume and cannot be adjusted.

**To cancel TIMER**

- During the beeper alarm: press any of the **TIMER** buttons, **10**, **3** or **1**.
- Before the **TIMER** goes off: press **10** once or repeatedly until □□ appears and **TIME** disappears.

# TUNER

## Tuning to stations

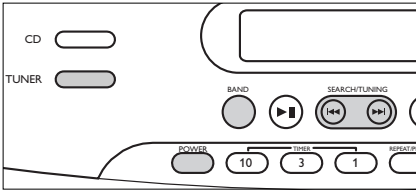

1. Press **POWER** to on, then select **TUNER**.
2. Press **BAND** once or more to select your desired waveband, FM or AM.
3. Tuning to stations:
  - Press down on **SEARCH/TUNING** **◀** or **▶** and release the button when the frequency in the display starts running.
  - The radio automatically tunes to a station of sufficient reception.
  - To tune to a weak station, press **◀** or **▶** briefly and repeatedly until you have found optimal reception.
4. Repeat step 3 if necessary until you find the desired station.

### To improve radio reception

For FM, extend and adjust the AC power cord.

## PRESETS: programming tuner stations

You can store up to 40 radio stations in the memory (20 FM and 20 AM).

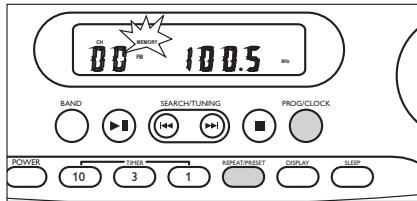

1. Tune to your desired station (see **Tuning to stations**).
2. Press **PROG/CLOCK** to activate programming.
  - Display: **MEMORY** flashes and **CH XX** appears, where **XX** denotes a preset location.
3. Press **REPEAT/PRESET** once or more to select a preset number, 1-20.
4. Press **PROG/CLOCK** to confirm.
  - Display shows: the preset number, waveband and the frequency of the preset station.
5. Repeat the above steps to store other stations.

### Helpful Hints:

– If you fail to execute any action within 7 seconds after pressing **PROG/CLOCK**, programming will stop and you will need to start again.

– You can erase a preset station by storing another frequency in its place.

### To listen to a preset station

- Press **REPEAT/PRESET** once or more until the desired preset station is displayed.

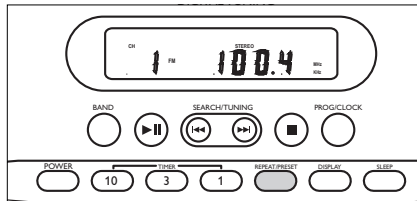

# CD PLAYER

## Playing a CD

This CD player plays Audio Discs including CD-Recordables. Do not try to play MP3 CD-ROMs, CD-I's, CDV, VCDs, DVDs, computer CDs or CD-Rewritables.

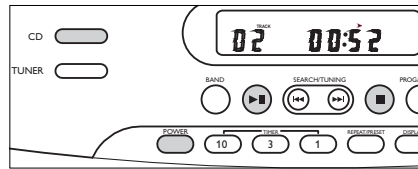

1. Press **POWER** to on, then select **CD**.
2. Press **OPEN•CLOSE** to open the CD compartment.
3. Insert a CD with the printed side facing up and press **OPEN•CLOSE** to close the CD compartment.
  - Display shows: **00 00:00**, and then the total track number and total playing time.
  - **no disc** appears if no disc is inserted, or you have inserted a non-finalized CD-R(W).
  - **01** and total playing time, if your CD contains non-audio/ MP3 files.
4. Press **▶** to start playback.
  - Display shows: the current track number, elapsed playing time and **▶**.
5. To pause playback press **▶**. Press **▶** again to resume play.
  - Time digits flash during pause.
6. To stop CD playback, press **■**.

### Helpful Hints:

The CD playback will also stop when:

- the CD compartment is opened.
- the CD has reached the end
- you select another sound source.

## Selecting a different track, ◀ / ▶



During playback, Briefly press **◀** or **▶** once or repeatedly until you find your desired track.

During stop or pause, Press **▶** to start playback after your desired track is selected.

## Finding a passage within a track

1. During playback, press and hold **◀** or **▶**.
  - The CD is played at high speed and low volume.
2. When you recognize the passage you want, release **◀** or **▶**.

## Selecting different playing modes: REPEAT

Before or during CD playback, you can select a **REPEAT** mode.

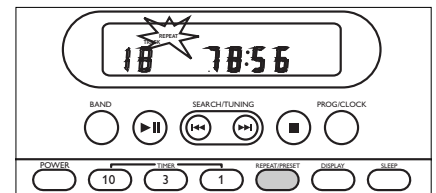

- To repeat the entire CD or a program, press **REPEAT/PRESET** once.
  - Display: **REPEAT** appears.
- To repeat a current track, press **REPEAT/PRESET** twice.
  - Display: **REPEAT** flashes.
  - Press **▶** to start playback if you have selected **REPEAT** in the stop or pause position.

## To resume normal playback

- Press **REPEAT/PRESET** once or more until **REPEAT** disappears from the display.

# MAINTENANCE AND SAFETY

## CD player and disc handling (see [2])

- If the CD player cannot read CDs correctly, use a cleaning CD to clean the lens before taking the set to repair.
- The lens of the CD player should never be touched!
- Sudden changes in the surrounding temperature can cause condensation on the lens of your CD player. Playing a CD is then not possible. Do not attempt to clean the lens, but leave the set in a warm environment until the moisture evaporates.
- Always close the CD door to avoid dust on the lens.
- To clean the CD, wipe in a straight line from the centre towards the edge using a soft, lint-free cloth. Do not use cleaning agents as they may damage the disc.
- Never write on a CD or attach any stickers to it.

## Safety Information (see [2])

- Don't expose the set, batteries, CDs or cassettes to humidity, rain, sand or excessive heat.
- Clean the set with a dry cloth. Don't use any cleaning agents containing alcohol, ammonia, benzene or abrasives as these may harm the set.
- Place the set on hard and flat surface so that the system does not tilt. Make sure there is good ventilation to prevent the set overheating.
- The mechanical parts of the set contain self-lubricating bearings and must not be oiled or lubricated.
- Apparatus shall not be exposed to dripping or splashing.
- Do not place any sources of danger on the apparatus (e.g. liquid filled objects, lighted candles).

## Canada

**English:** This digital apparatus does not exceed the Class B limits for radio noise emissions from digital apparatus as set out in the Radio Interference Regulations of the Canadian Department of Communications.

**Français:** Cet appareil numérique n'émet pas de bruits radioélectriques dépassant les limites applicables aux appareils numériques de Classe B prescrites dans le Règlement sur le Brouillage Radioélectrique édicté par le Ministère des Communications du Canada.

The set complies with the FCC-Rules, Part 15 and with 21 CFR 1040.10.

Operation is subject to the following two conditions:

1. This device may not cause harmful interference, and
2. This device must accept any interference received, including interference that may cause undesired operation.

# TROUBLESHOOTING

If a fault occurs, first check the points listed below before taking the set to repair. If you are unable to remedy a problem by following these hints, consult your dealer or service center.

**WARNING: Do not open the set as there is a risk of electric shock! Under no circumstances should you try to repair the set yourself, as this will invalidate the warranty.**

## No sound/power

- Volume not adjusted.
- Adjust the **VOLUME**.
- Power cord not securely connected.
- Connect the AC power cord properly.
- Electrostatic discharge/interference.
- Unplug the set and remove battery from the battery compartment. Then, replug /replace battery. Try activating the set again.
- CD contains non-audio files.
- Press **SEARCH** **◀** or **▶** once or more skip the data file to a suitable audio track.

## Severe radio hum or noise

- Electrical interference: set too close to TV, VCR or computer.
- Move the set/ TV, VCR or computer to increase the distance.

## Poor radio reception

- Weak radio signal.
- FM: Extend and adjust AC power cord.

## no disc indication

- No CD inserted.
- Insert a suitable disc.
- CD badly scratched or dirty.
- Replace/clean CD (See Maintenance).
- Laser lens steam up.
- Wait until lens has cleared.

## 01 and total playing time indication

- CD-ROM disc inserted/CD contains non-audio files.
- Use CD Audio discs only, or press **SEARCH** **◀** or **▶** once or more skip the data file to a suitable audio track.

## The CD skips tracks

- CD damaged or dirty.
- Replace or clean CD.
- Program is active
- Switch off program.

## Environmental information

We have done our best to reduce the packaging and make it easy to separate into 3 materials: cardboard, expandable polystyrene, polyethylene.

**Your set consists of materials which can be recycled if disassembled by a specialized company. Please observe the local regulations regarding the disposal of packaging, dead batteries and old equipment.**